

GPLM393

DUAL DIFFERENTIAL COMPARATOR

Description

The GPLM393 consists of two independent voltage comparators, designed specifically to operate from a single power over a wide voltage range.

Features

- *Single or dual supply operation.
- *Wide operating supply range($V_{CC}=2V \sim 36V$ or ± 1 to $\pm 18V$).
- *Input common-mode voltage includes ground.
- *Low supply current drain $I_{CC} = 0.8mA$ (Typical).
- *Low input bias current $I_{bias} = 25nA$ (Typical)
- *Output compatible with TTL, DTL, and CMOS logic system.

Package Dimensions

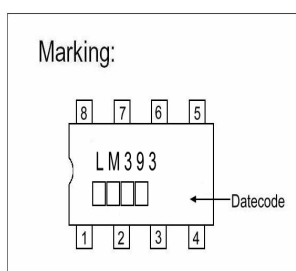
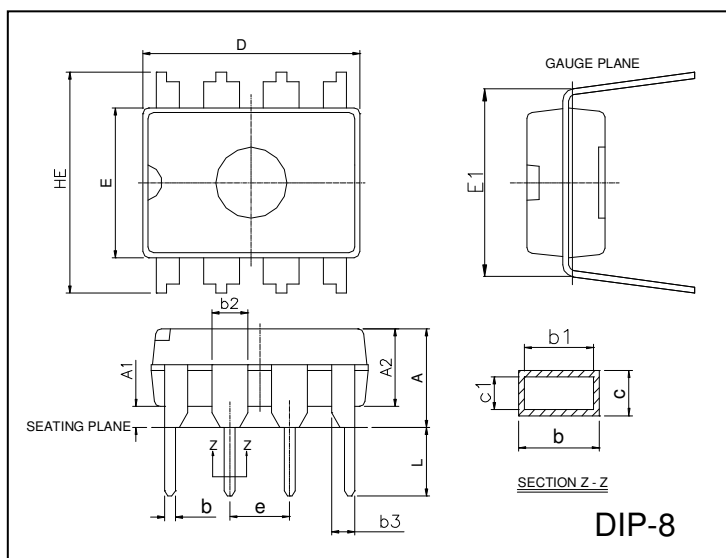

REF.	Millimeter		REF.	Millimeter	
	Min.	Max.		Min.	Max.
A	-	0.5334	c1	0.203	0.279
A1	0.381	-	D	9.017	10.16
A2	2.921	4.953	E	6.096	7.112
b	0.356	0.559	E1	7.620	8.255
b1	0.356	0.508	e	2.540 BSC	
b2	1.143	1.778	HE	-	10.92
b3	0.762	1.143	L	2.921	3.810
c	0.203	0.356			

Pin Configurations

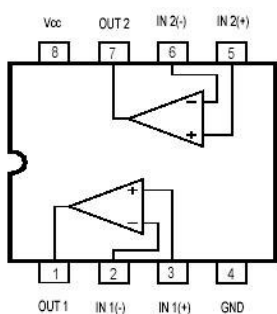

Block Diagram

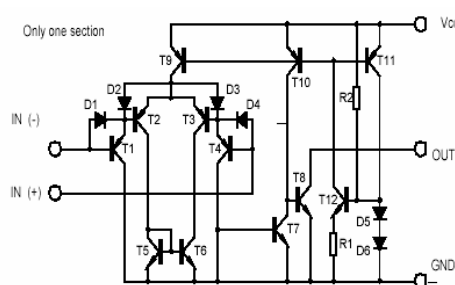

Absolute Maximum Ratings at $T_a = 25^{\circ}C$

Parameter	Symbol	VALUE	Unit
Supply Voltage	V_{CC}	± 18 or 36	V
Differential Input Voltage	V_{IDiff}	36	V
Input voltage	V_I	-0.3~36	V
Power Dissipation	PD	570	mW
Operating Temperature	T_{opr}	0~+70	$^{\circ}C$
Storage Temperature	T_{stg}	-65 to 150	$^{\circ}C$

Electrical Characteristics($V_{CC}=5V, T_a=25^{\circ}C, R_T=10k$, All voltage referenced to GND unless otherwise specified)

Parameter	SYMBOL	Test Conditions	MIN	Typ.	Max.	Unit
Input Offset Voltage	VIO	$V_{CM}=0$ TO $V_{CC}-1.5$ $V_{o(p)} = 1.4V, R_s=0$		± 1.0	± 5.0	mV
Input Offset Current	IIO			± 5	± 50	nA
Input Bias Current	Ib			65	250	nA
Input Common-Mode Voltage Range	VI(R)		0		$V_{CC}-1.5$	V
Supply Current	Icc	$R_L=\infty$		0.6	1.0	mA
		$R_L=\infty, V_{CC}=30V$		0.8	2.5	mA
Large Signal Voltage Gain	Gv	$V_{CC}=15V, R_L>15K\Omega$	50	200		V/mV
Large Signal Response Time	tres	$V_i=TTL$ logic wing $V_{ref}=1.4V, V_{RL}=5V, R_L=5.1K\Omega$		350		ns
Response Time	tres	$V_{RL}=5V, R_L=5.1K\Omega$		1400		ns
Output Sink Current	I _{sink}	$V_i(-)>1V, V_i(+)=0V, V_{o(p)}<1.5V$	6	18		mA
Output Saturation Voltage	V _{sat}	$V_i(-)>1V, V_i(+)=0V, I_{sink}=4mA$		160	400	mV
Output Leakage Current	I _{leakage}	$V_i(+)=1V, V_i(-)=0$				
		$V_{o(p)}=5V$		0.1		nA
		$V_{o(p)}=30V$			1.0	uA

Typical Performance Characteristics

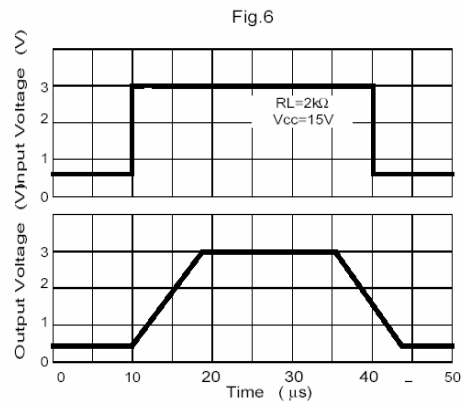
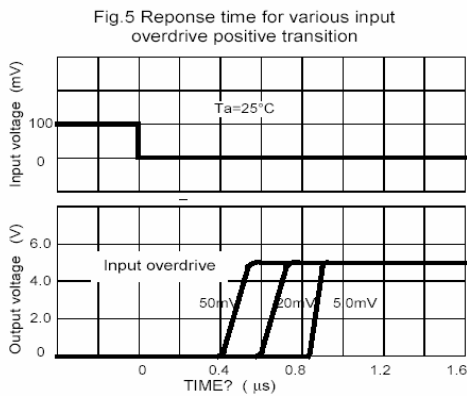
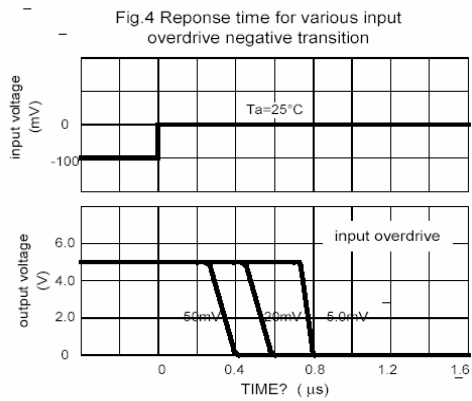
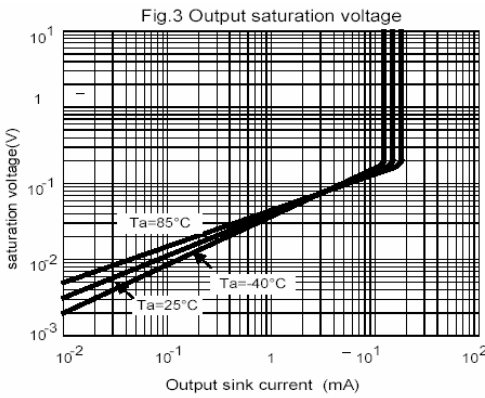
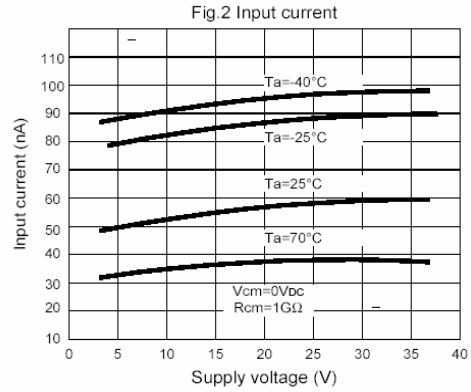
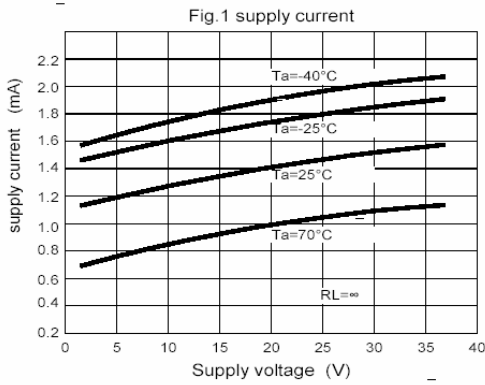

Fig.7 voltage Follower pulse response (small signal)

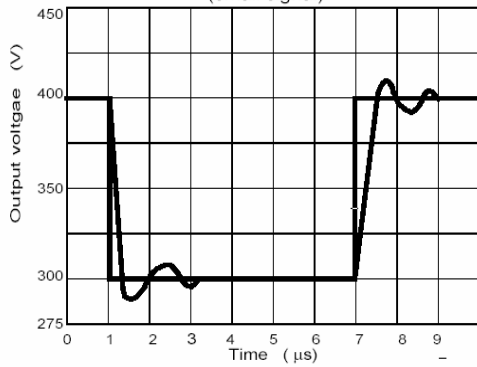

Fig.8 Large signal Frequency Response

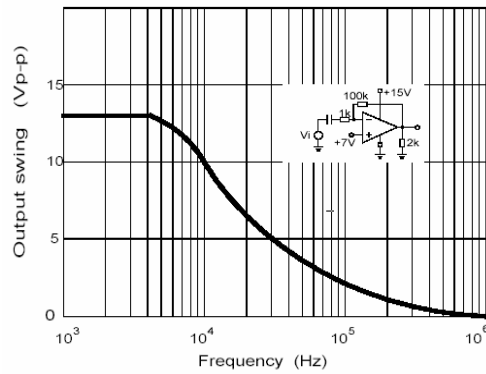

Fig.9 Output Characteristics current sourcing

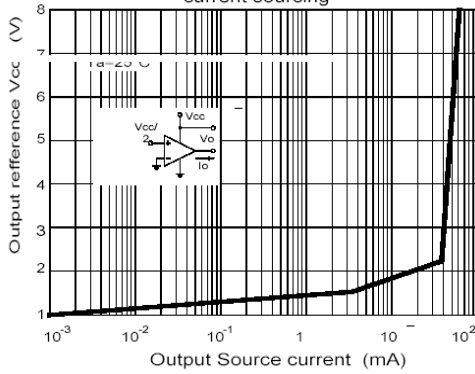

Fig.10 Output Characteristics Current sinking

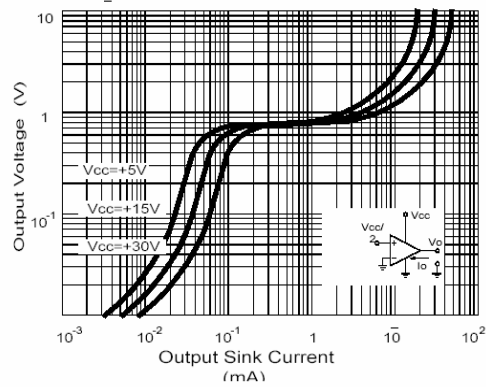
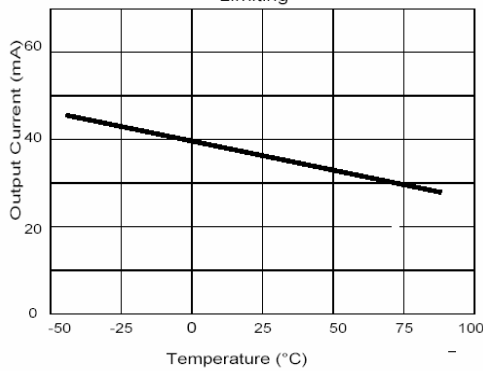

Fig.11 Current Limiting



Important Notice:

- All rights are reserved. Reproduction in whole or in part is prohibited without the prior written approval of GTM.
- GTM reserves the right to make changes to its products without notice.
- GTM semiconductor products are not warranted to be suitable for use in life-support Applications, or systems.
- GTM assumes no liability for any consequence of customer product design, infringement of patents, or application assistance.

Head Office And Factory:

- **Taiwan:** No. 17-1 Tatung Rd. Fu Kou Hsin-Chu Industrial Park, Hsin-Chu, Taiwan, R. O. C.
 TEL : 886-3-597-7061 FAX : 886-3-597-9220, 597-0785
- **China:** (201203) No.255, Jang-Jiang Tsai-Lueng RD. , Pu-Dung-Hsin District, Shang-Hai City, China
 TEL : 86-21-5895-7671 ~ 4 FAX : 86-21-38950165